

Flexible Intensifier® Technology Bullet IP Camera
QUICK INSTALLATION GUIDE



O6FB7M

Please read this manual carefully before installation and operation of the product.

Notice

Thank you for purchasing this product. This guide is designed to be a reference tool for the product. Please read it carefully before operating the product and retain it for future reference. Should you require any technical assistance, please contact Speco Technologies Technical Support.



The lightning flash with an arrowhead symbol, within an equilateral triangle is intended to alert the user to the presence of non-insulated dangerous voltage within the product's enclosure that may be of sufficient magnitude to constitute a risk of electric shock to persons.



The exclamation point within an equilateral triangle is intended to alert the user to the presence of important operating and maintenance (servicing) instructions in the literature accompanying the appliance.

INFORMATION

This equipment has been tested and found to comply with limits for a Class A digital device, pursuant to part 15 of the FCC Rules. These limits are designed to provide reasonable protection against harmful interference when the equipment is operated in a commercial environment. This equipment generates, uses, and can radiate radio frequency energy and, if not installed and used in accordance with the instruction manual, may cause harmful interference to radio communications. Operation of this equipment in a residential area is likely to cause harmful interference in which case the user will be required to correct the interference at its own expense.

WARNING

Changes or modifications not expressly approved by the manufacturer could void the user's authority to operate the equipment.

CAUTION – To prevent electric shock and risk of the fire hazards

- Do NOT use power source other than that specified.
- Do NOT expose this appliance to rain or moisture.

This installation should be made by a qualified service person and should conform to all local codes.

PRECAUTIONS

- Please read the manual carefully before the installation in order to set up the camera correctly and to obtain the best picture quality.
- Please keep the manual in good condition for your future reference and service application.
- Installation and services should only be carried out by an authorized personnel according to local safety regulations.
- If any liquid or solid matter gets into the housing, immediately disconnect the camera from power supply and have it checked by your authorized dealer before reusing.
- Avoid installing the camera at extremely hot or cold places.
- If you are not a certified person, never try to dismantle the camera.
To avoid electric shock, never remove the screws or covers. There are no parts inside that need maintenance by the user. All maintenance should be carried out by qualified personnel.
- Avoid installing the camera at a place of high humidity.
- Avoid installing the camera at the place exposed to gas or oil.
- Keep the top glass of the lens always clean in order to obtain the best picture quality all the time. Be careful not to be stained by fingerprint.
- Don't face the camera directly toward sunlight or sunlight reflecting area.
IMAGE SENSOR may go defective at this condition.
- Please give a special attention to keep the unit from dangerous drop or external shock during the process of transportation or handling.
- Never try to touch the camera in wet hand. It may cause an electric shock.
- Do not expose the camera to radioactivity. It causes a serious damage on the IMAGE SENSOR.

LIMITATION OF LIABILITY

This publication is provided "AS IS" without warranty of any kind, either express or implied, including but not limited to, the implied warranties of merchantability, fitness for any particular purpose, or non-infringement of the third party's right.

This publication could include technical inaccuracies or typographical errors. Changes are added to the information herein, at any time, for the improvements of this publication and / or the corresponding product(s).

DISCLAIMER OF WARRANTY

In no event shall seller be liable to any party or any person, except for replacement or reasonable maintenance of the product, for the cases, including but not limited to below :

- (1) Any damage and loss, including without limitation, direct or indirect, special, consequential or exemplary, arising out of or relating to the product.
- (2) Personal injury or any damage caused by inappropriate use or negligent operation of the user.
- (3) Unauthorized disassemble, repair or modification of the product by the user.
- (4) Inconvenience or any loss arising when images are not displayed, due to any reason or cause including any failure or problem of the product.
- (5) Any problem, consequential inconvenience, or loss or damage, arising out of the system combined by the devices of third party.
- (6) Any claim or action for damages, brought by any person or organization being photogenic subject, due to violation of privacy with the result of that surveillance-camera's or video server's picture, including saved data, for some reason, becomes public or is used for the purpose other than surveillance.

1. PRODUCT OVERVIEW

Key Features

- 6.82 Mega pixel 1/2.9" SONY progressive scan CMOS image sensor for excellent image quality
- IP67 rated water-proof
- Triple Streaming of H.265, H.264 and M-JPEG
- Supports image resolutions 6M (3072 x 2048)
- Integrated motion detection with pre- and post-alarm image / video buffering
- Supports CBR (Constant Bit Rate) and VBR (Variable Bit Rate) modes
- Supports Tampering-Alarm in VA (Video Analytics) function
- Controllable frame rate
- Full Duplex Two-Way Audio Support
- External Audio Line-input & Audio Line-output connector
- External sensors or external alarm devices
- Privacy Masking
- Supports IEEE 802.3af Power over Ethernet injectors, mid- and end-spans
- HTTPS supported (Hyper Text Transfer Protocol Secured)
- Integrated E-Mail, FTP, DDNS and DHCP client

Specification













CLASSIFICATION		Night Vision Bullet IR Camera	
General	CPU	ARM Cortex-A9 816MHz CPU with L2 cache	
	Flash	2Gbit Flash Memory	
	SDRAM	8Gbit DDR3 Memory	
Image Pickup	Image Sensor	6.82 Mega 1/2.9" SONY STARVIS image sensor	
	Total Pixels	3096(H) x 2218(V) 6.87 Megapixel	
	Effective Pixels	3096(H) x 2202(V) 6.82 Megapixel	
	S/N Ratio	More than 50dB	
	Min. Illumination	0Lux (IR On)	
	IR Distance	40M	
	Day & Night	Auto, Color, BW	
	Lens	2.7 ~ 12mm Vari-focal Motorized Megapixel Lens	
Video	Video Compression	H.265 / HEVC Main Profile Level 5.1 encoding H.264 High profile @ Level 5.1 MJPEG	
	Resolutions	Up to 3072 x 2048 @ 20fps	
	Frame Rate	H.265 / H.264 Up to 20fps with 3072 x 2048, H.265 / H.264 Up to 15fps with 640 x 360 H.264 / MJPEG Up to 5fps with 640 x 360	
	Video Streaming	Support multi stream with H.265 / H.264, Adjustable frame rate, VBR / CBR	
	Image Setting		Brightness, Contrast, Sharpness
			Day & Night, Auto White Balance, Auto Exposure
			Privacy Mask
			DSS, 3DNR
			V-Flip, etc.
Video Output	WDR, ATR		
	Video Output	BNC x1, 1.0Vp-p, 75 ohm Composite Video, NTSC / PAL	
Audio	Audio Streaming	Two-way, full duplex	
	Audio Compression	G.711	
	Data / Sample Rate	64Kbps / 8KHz	
	Audio Input / Output	Microphone input / 1x Line-In, Line-Output / 1x Line-Out	
Network	Security	Password protection, User access log, HTTPS encryption	
	Supported Protocol	HTTP, HTTPS, DNS, RTSP, RTP, TCP, UDP, ICMP, DHCP	

System Integration	Intelligent Video	Motion detection (4 Separate blocks)
	Alarm Trigger	Motion Detection
	Firmware Upgrade	Remote Upgrade via Network
Physical	Etc	1 x Factory Reset Button
	Memory Slot	Micro SD card
	Power Source	DC 12V / 1.5A, POE (Power Over Ethernet) : 802.3af
	Power Consumption	Max.7.2W (IR ON)
	Net Weight	1060g (Camera Only)
	State LED's	Power, Network Connection
	Dimension(mm)	Ø98.5 x 262.5 Including Bracket
Environment	Operating Temperature	-40 degree ~ 60 degree Celsius (-40F ~ 140F)
	Storage Temperature	-20 degree ~ 60 degree Celsius (-4F ~ 140F)

※ Specifications are subject to change without prior notice for improvement.

2. NAME AND FUNCTION OF EACH PART

2.1 Package Contents

APPEARANCE	DESCRIPTION
	IP Camera x 1
	Installation Guide x 1
	Tapping screw (Ø4 x 30) x 4
	Plastic anchor x 4
	L-Wrench (4mm) x 1
	L-Wrench (2.5mm) x 1
	CD x 1
Junction Box	
	Top Rubber x 1
	Junction Box x 1
	Sponge x 1
	Tapping Screws (Ø4 x 30) x 4
	Plastic Anchor x 4
	Screw PH (M4 x 12) x 4

2.2 Name and Function

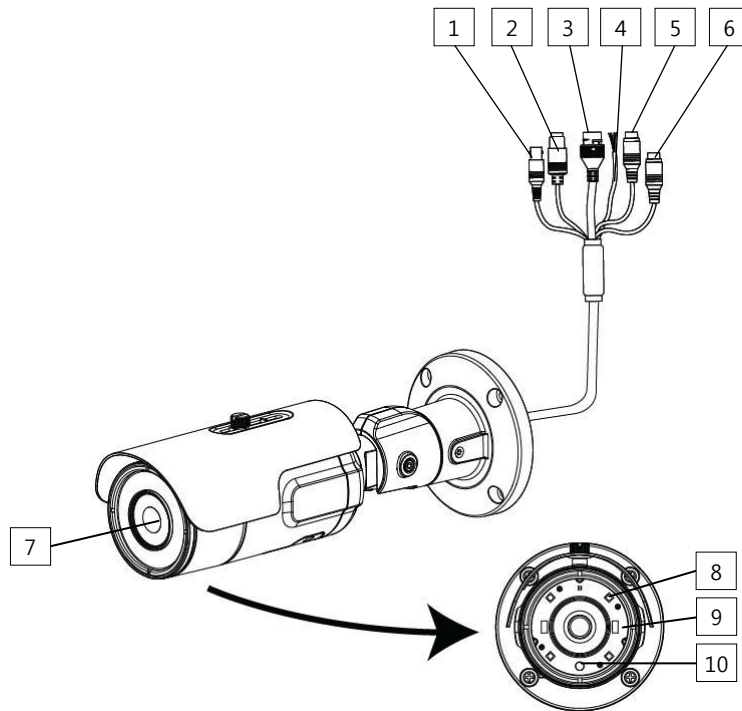

NO.	ITEM	DESCRIPTION
1	BNC	Analog Video Out (Yellow)
2	Power Connector	DC12V
3	Network and POE Connector	POE (Power Over Ethernet) and LAN cable
4	Sensor In / Alarm Out	Sensor Input : White (Sensor_In), Yellow (GND) Alarm Output : Black (Alarm_Out), Red (COM)
5	Audio-Out	Audio Out (White)
6	Audio-In	Audio in (Red)
7	Lens	2.7 ~ 12mm Vari-focal Motorized Megapixel Lens
8	IR LED	Infrared Hi-power LED
9	Heater	Resistors reduce condensation on front glass
10	Illumination sensor	Control IR LED by sensing light

2.3 OSD cap detailed description

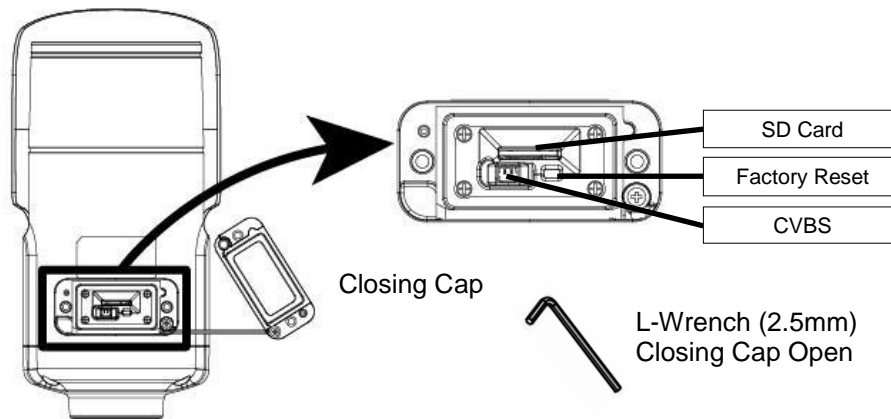

※ Open the Closing Cap and fasten the Closing Cap well.

3. INSTALLATION

3.1 How to mount to wall

• Wall_Junction Box

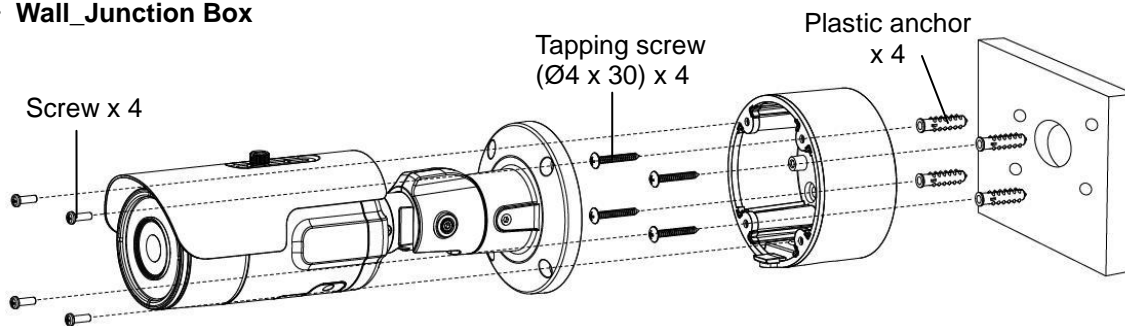

• Wall

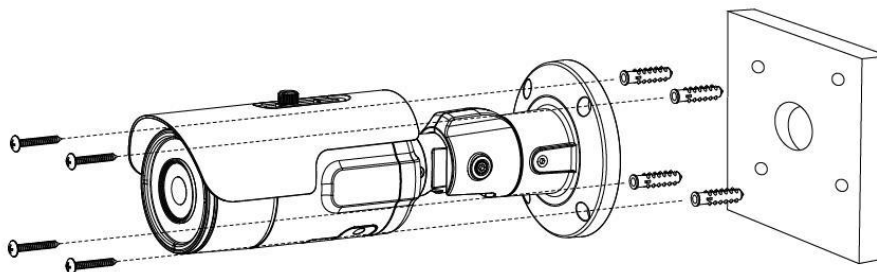

- ① Drill four screw holes on the wall plate to fix four plastic anchors (supplied) in the holes.
- ② Fix the plastic anchors in the holes.
- ③ Position the bracket on the screw points.
- ④ Fix the bracket by tightening the screws.

3.2 3-Axis Adjustment

① Panning 360°
Slightly loosen Pan Bracket nut then adjust pan of the camera and tighten the Bracket nut.

② Tilt 0° ~ 100°
Slightly loosen Tilt bolt then adjust tilt of the camera and tighten the bolt firmly.

③ Rotation 360°
Slightly loosen Tilt bolt then adjust rotation of the camera and tighten the bolt firmly.

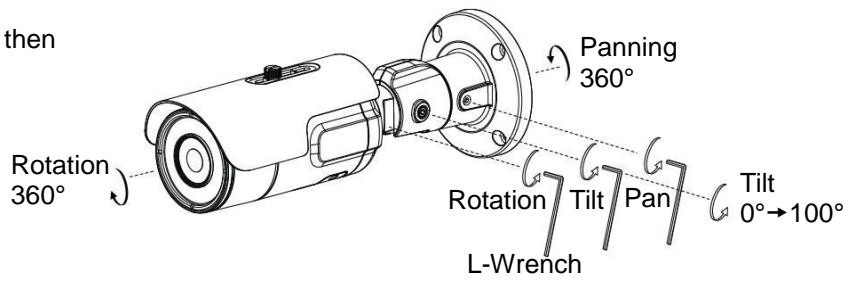

3.3 Installation Example

3.3.1 Installation Example

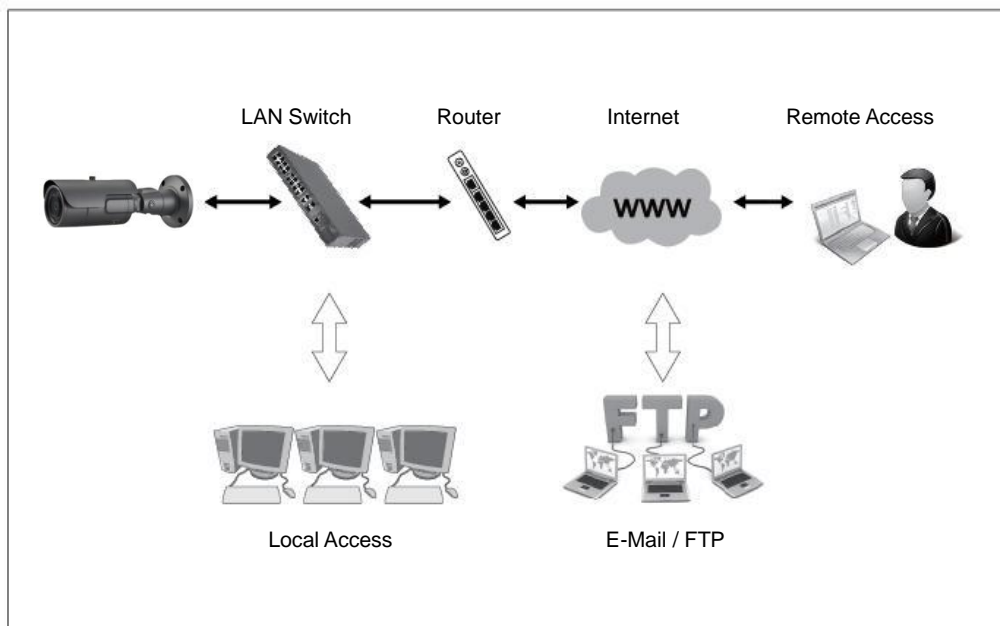

3.3.2 Connecting Network

Open up IP Scanner.

IP Scanner can search for the device on the local network.

Please note that only devices that are on the same subnet can be discovered.

The device is set to DHCP mode by default.

In the device list, you can view the IP address, model number, and MAC address of each device. Select the applicable device and double click to open up the web viewer.

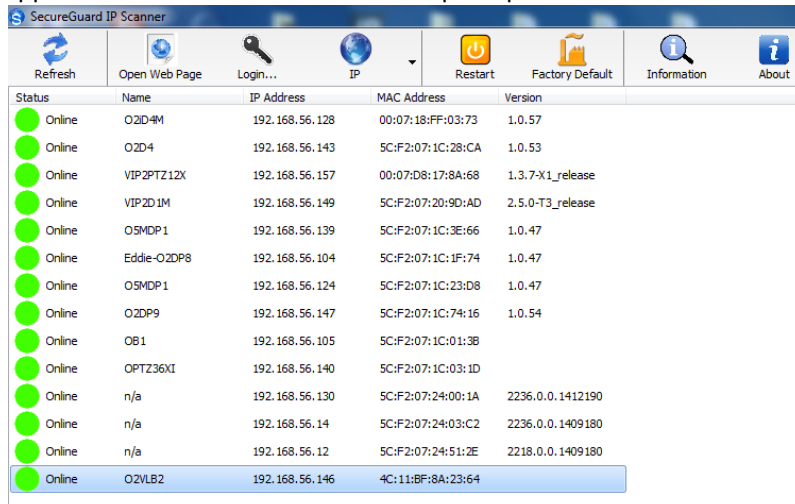

Status	Name	IP Address	MAC Address	Version
Online	O2D4M	192.168.56.128	00:07:18:FF:03:73	1.0.57
Online	O2D4	192.168.56.143	5C:F2:07:1C:28:CA	1.0.53
Online	VIP2PTZ12X	192.168.56.157	00:07:D8:17:8A:68	1.3.7-X1_release
Online	VIP2D1M	192.168.56.149	5C:F2:07:20:9D:AD	2.5.0-T3_release
Online	OSMDP1	192.168.56.139	5C:F2:07:1C:3E:66	1.0.47
Online	Eddie-O2DP8	192.168.56.104	5C:F2:07:1C:1F:74	1.0.47
Online	OSMDP1	192.168.56.124	5C:F2:07:1C:23:D8	1.0.47
Online	O2DP9	192.168.56.147	5C:F2:07:1C:74:16	1.0.54
Online	OB1	192.168.56.105	5C:F2:07:1C:01:38	
Online	OPTZ36XI	192.168.56.140	5C:F2:07:1C:03:1D	
Online	n/a	192.168.56.130	5C:F2:07:24:00:1A	2236.0.0.1412190
Online	n/a	192.168.56.14	5C:F2:07:24:03:C2	2236.0.0.1409180
Online	n/a	192.168.56.12	5C:F2:07:24:51:2E	2218.0.0.1409180
Online	O2VLB2	192.168.56.146	4C:11:BF:8A:23:64	

3.3.3 Accessing the Camera or video server's Homepage

1) Open the browser and enter the camera's IP address in the address bar or double click the device in IP Scanner.

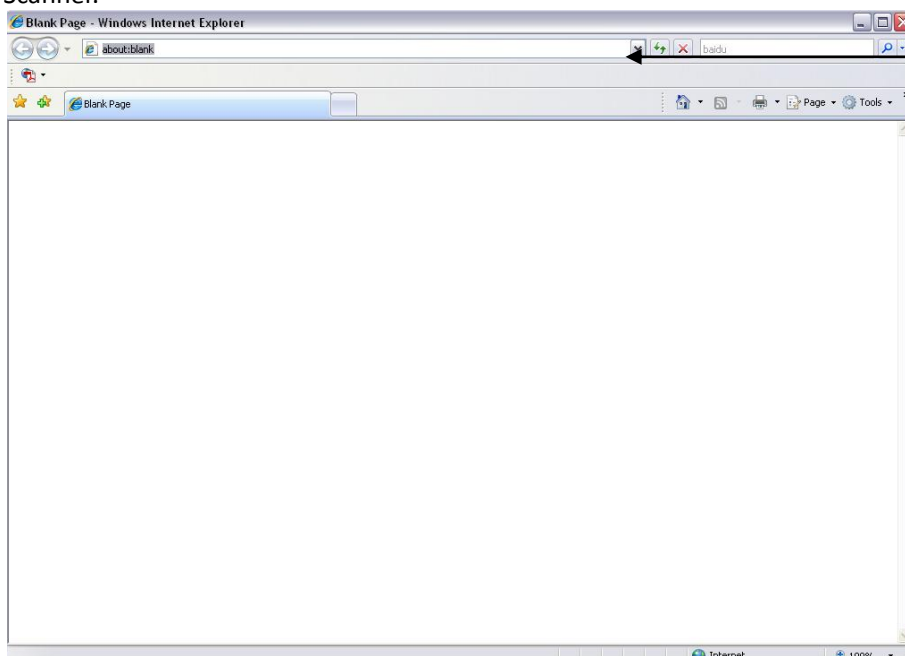

Enter the IP address here

2) Enter the user name and password when prompted.

3) Default user name is **admin** and password is **1234**.

4) If prompted for installation of the Active-X plug-in, allow the installation. Active-X is needed to view video from Internet Explorer.

4. DIMENSIONS (mm)

