

HD-TVI 2MP Intensifier® Bullet Camera

QUICK INSTALLATION GUIDE



HTINT702TA

◆ Special features

- Sony 1/2.9 inch 2.1MP Exmor CMOS Sensor
- 5 – 50mm Motorized Zoom & Focus Control
- Supports image resolution up to 1920 x 1080P @ 30fps
- Wide Dynamic Range (15fps)
- Full OSD operation through on-board control and UTC
- 2D & 3D noise reduction
- SENS-UP (Digital Slow Shutter)
- Privacy masking (16zone)
- Dynamic Motion Detection (4zone)
- Defog
- Surge Protect (DC 2KV / Video 3KV)
- Tool-free 3-Axis
- IP67 Weatherproof
- 12VDC / 24VAC Dual Input
- Built-in Heater

DEAR CUSTOMERS!

By selecting this product, you have decided to use a professional device that guarantees highest quality and reliability. We would like to thank you very much for your confidence and kindly ask you to read the following instructions carefully before installation and operation in order to take full advantage of all quality features regarding this product.



The lightning flash with an arrowhead symbol, within an equilateral triangle is intended to alert the user to the presence of non-insulated dangerous voltage within the product's enclosure that may be of sufficient magnitude to constitute a risk of electric shock to persons.



The exclamation point within an equilateral triangle is intended to alert the user to the presence of important operating and maintenance (servicing) instructions in the literature accompanying the appliance.

INFORMATION

This equipment has been tested and found to comply with limits for a Class A digital device, pursuant to part 15 of the FCC Rules. These limits are designed to provide reasonable protection against harmful interference when the equipment is operated in a commercial environment. This equipment generates, uses, and can radiate radio frequency energy and, if not installed and used in accordance with the instruction manual, may cause harmful interference to radio communications. Operation of this equipment in a residential area is likely to cause harmful interference in which case the user will be required to correct the interference at his own expense.

WARNING

Changes or modifications not expressly approved by the manufacturer could void the user's authority to operate the equipment.

CAUTION – To prevent electric shock and risk of the fire hazards

- Do NOT use power source other than that specified.
- Do NOT expose this appliance to rain or moisture.

This installation should be made by a qualified service person and should conform to all local codes.

1. Precautions

- Please read the manual carefully before the installation in order to make use the camera to be set up correctly and to have the best picture quality.
- Please keep the manual in good condition for your future reference and service application.
- Installation and services should only be carried out by an authorized personnel according to local safety regulations.
- If any liquid or solid matter gets into the housing, immediately disconnect the camera from power supply and have it checked by your authorized dealer before reusing.
- Avoid installing the camera at extremely hot or cold places.
- If you are not a certified person, never try to dismantle the camera.
- To avoid electric shock, never remove the screws or covers. There are no parts inside that need maintenance by the user. All maintenance should be carried out by qualified personnel.
- Avoid installing the camera at a place of high humidity.
- Avoid installing the camera at the place exposed to gas or oil.
- Keep the top glass of the lens always clean in order to obtain the best picture quality all the time. Be careful not to be stained by fingerprint.
- Don't face the camera directly toward sunlight or sunlight reflecting area. CMOS may go defective at this condition.
- Please give a special attention to keep the unit from dangerous drop or external shock during the process of transportation or handling.
- Never try to touch the camera in wet hand. It may cause an electric shock.
- Do not expose the camera to radioactivity. It causes a serious damage on the CMOS.

2. Limitation of liability

This publication is provided "AS IS" without warranty of any kind, either express or implied, including but not limited to, the implied warranties of merchantability, fitness for any particular purpose, or non-infringement of the third party's right. This publication could include technical inaccuracies or typographical errors. Changes are added to the information herein, at any time, for the improvements of this publication and / or the corresponding product(s).

3. Disclaimer of warranty

In no event shall seller be liable to any party or any person, except for replacement or reasonable maintenance of the product, for the cases, including but not limited to below :

- (1) Any damage and loss, including without limitation, direct or indirect, special, consequential or exemplary, arising out of or relating to the product.
- (2) Personal injury or any damage caused by inappropriate use or negligent operation of the user.
- (3) Unauthorized disassemble, repair or modification of the product by the user.
- (4) Inconvenience or any loss arising when images are not displayed, due to any reason or cause including any failure or problem of the product.
- (5) Any problem, consequential inconvenience, or loss or damage, arising out of the system combined by the devices of third party.
- (6) Any claim or action for damages, brought by any person or organization being photogenic subject, due to violation of privacy with the result of that surveillance-camera's picture, including saved data, for some reason, becomes public or is used for the purpose other than surveillance.

4. Package

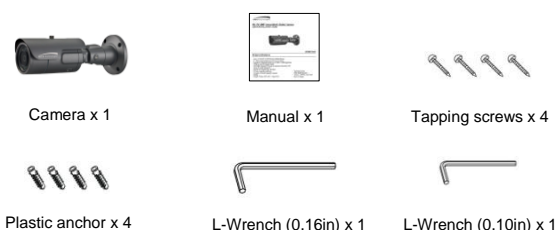

4. Package

- Junction Box

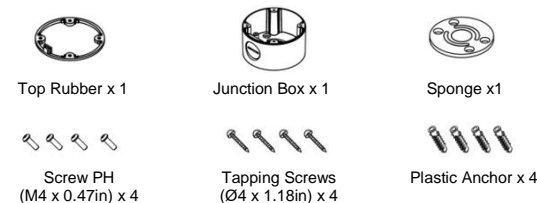

5. Installation

5-1. How to install on the Wall

• Wall Junction Box

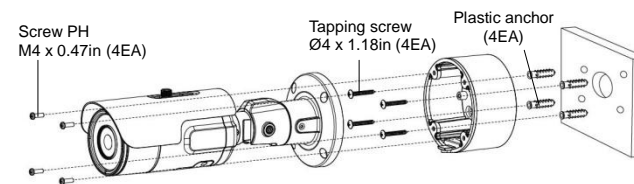

• Wall

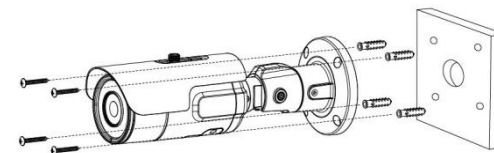

- ① Drill four screw holes on the wall plate to fix four plastic anchors (supplied) in the holes.
- ② Fix the plastic anchors in the holes.
- ③ Position the bracket on the screw points.
- ④ Fix the bracket by tightening the screws.

5-2. OSD cap detailed description

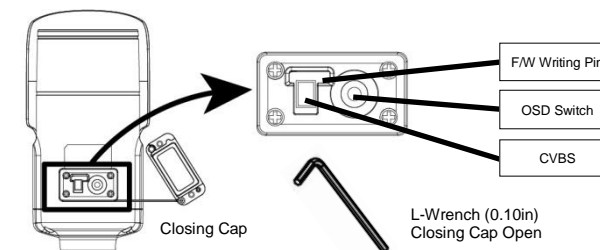

× Open the Closing Cap and fasten the Closing Cap well.

5. Installation

5-3. Tool-free 3-Axis mounting mechanism

- ① Panning 360°
Slightly loosen Pan Bracket nut then adjust pan of the camera and tighten the Bracket nut.
- ② Tilt 0° ~ 100°
Slightly loosen Tilt bolt then adjust tilt of the camera and tighten the bolt firmly.
- ③ Rotation 360°
Slightly loosen Tilt bolt then adjust rotation of the camera and tighten the bolt firmly.

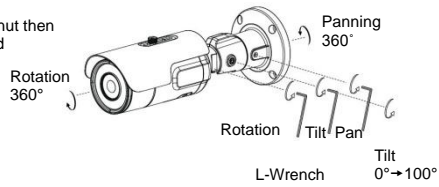

5-4. Application of TVI output

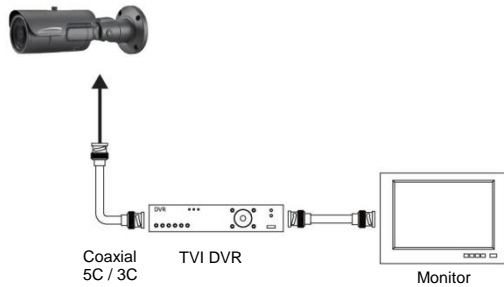

6. Function and operation

6-1. On Screen Display (On board control and UTC)

PRESET MENU					
INDOOR / OUTDOOR / LOW LIGHT / HALLWAY / LOBBY / ELEVATOR					
SETUP					
LENS	DC	MANUAL			
EXPOSURE	BRIGHTNESS	SHUTTER	INTENSIFY	AGC	RETURN
WHITE BAL	AUTO	AWB	AWC-SET	MANUAL	
BACKLIGHT	WDR	BLC	HLC	OFF	
DAY&NIGHT	COLOR	B/W	AUTO		
DNR	LOW	MIDDLE	HIGH		RETURN
IMAGE	SHARPNESS	GAMMA	COLOR GAIN	MIRROR	FLIP
	ACE	DEFOG	RETURN		
MOTION	ON	OFF			
SYSTEM	ANALOG HD	FRAME RATE	FREQ	IMAGE RANGE	COLOR SPACE
	COLOR BAR	LANGUAGE	CAM TITLE	CAM TITLE	HEATER
	RESET	RETURN			
EXIT					

7. Troubleshooting

If there are problems in operating, please refer to the checklist below.
If the problem persists, please contact the agent where this product is purchased.

Problems	Troubleshooting
Nothing appears on the screen.	<ul style="list-style-type: none"> Please check that the power cord and line connection between the camera and monitor are fixed properly. Please check that you have properly connected Video cable to the camera Video output jack.
The dim image on the screen.	<ul style="list-style-type: none"> Is lens stained with dirt? Clean your lens with soft, clean cloth. Set the monitor to proper condition. If the camera is exposed to too strong light, change the camera position. Please check if the power supply is within the specification & cables. (Due to the voltage drop with distance and gauges, Led will light poor)
The dark image on the screen.	<ul style="list-style-type: none"> Adjust the contrast feature of the monitor. If there is an intermediate device, set the 75Ω / Hi-Z properly. (Please check the impedance)
The camera is not working properly, and the body of the camera is hot.	<ul style="list-style-type: none"> Please check if the power supply is regulated and is within the standard requirement of the products.
Color is not correct.	<ul style="list-style-type: none"> Please check the setting of White Balance setup.
The screen is flickering.	<ul style="list-style-type: none"> Please check if the camera is facing directly towards sunlight or fluorescent light.

9. Specifications

MODEL	HTINT702TA
Image sensor	Sony 1/2.9 inch 2.1MP Exmor CMOS Sensor
Total Pixel	2001(H) x 1121(V) 2.24M Pixels
Effective Pixels	1985(H) x 1105(V) 2.19M Pixels
Scanning system	Progressive scan
Video output	1920 x 1080 25p / 30p
Output	TVI / CVBS
S/N ratio	More than 52dB (AGC OFF / Weight ON)
Min. Illumination	0.01Lux
Privacy Mask	ON / OFF (16 zone)
Motion Detection	ON / OFF (4 zone)
NEG.Image	ON / OFF
Mirror / Flip	ON / OFF
White Balance	AUTO / AWB / AWB - SET / MANUAL
Shutter Speed	AUTO / MANUAL / FLICKER
Sens-up	AUTO / OFF (Selectable Limit x2 ~ x32)
Backlight	OFF / HLC / BLC / WDR
2D / 3DNR	OFF / LOW / MIDDLE / HIGH
Gain Control	0 ~ 10 (Level adjustable)
Day & Night	AUTO / COLOR / B&W
Sharpness	0 ~ 10 (Level adjustable)
WDR	NORMAL / ROI
Lens Shading	ON / OFF
Defog	ON / OFF
Language	ENG, CHN, CHN(S), JPN, KOR
Lens	5 ~ 50mm DC Iris Varifocal MFZ Lens
Power Source	12VDC / 24VDC
Operating current	240mA±10%(12VDC) / 120mA±10%(24VAC)
Operating Temperature	-4F ~ 122F
Storage Temperature	-4F ~ 122F
Operating Humidity	0%RH ~ 90%RH
Measurement (in)	Ø98.5 x 10.3 Including Bracket
Weight(Approx. lbs)	2.31lbs (Camera Only)

× Specifications are subject to change without prior notice for better improvement.

8. Dimension (mm)

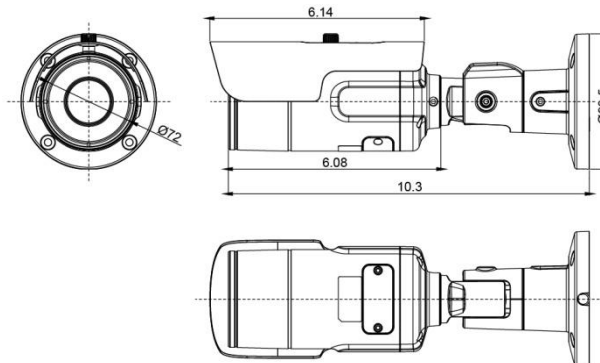

Federal Communications Commission (FCC) Statements

This device complies with Part 15 of the FCC Rules. Operation is subject to the following two conditions:
(1) This device may not cause harmful interference, and
(2) This device must accept any interference received, including interference that may cause undesired operation.

FCC Responsible Party :

Speco Technologies
200 New Highway
Amityville, NY 11701
www.specotech.com