



USER MANUAL

True RMS 600A

Solar Clamp

Meter with

METERLiNK®

Model CM65

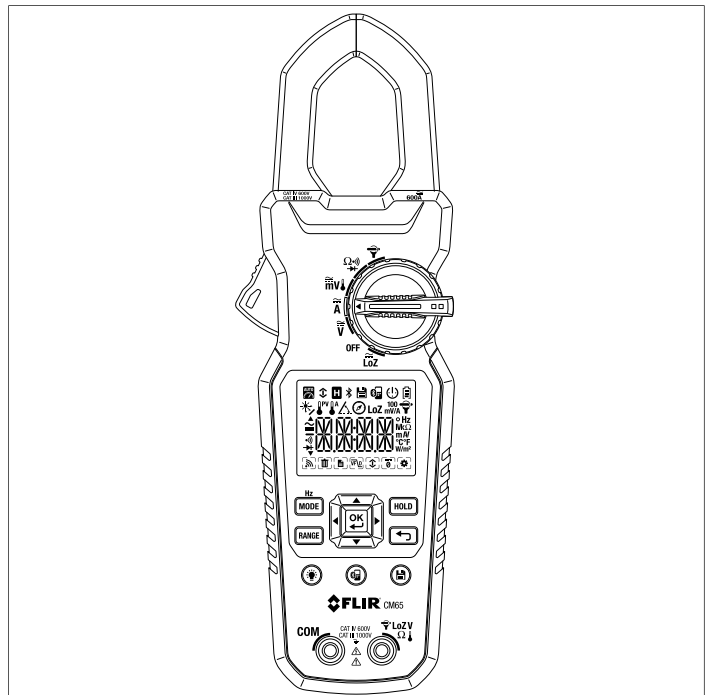



USER MANUAL

True RMS 600A Solar Clamp Meter with METERLiNK®

Table of contents

1	Advisories	1
1.1	Copyright.....	1
1.2	Quality Assurance	1
1.3	Documentation	1
1.4	Disposal of Electronic Waste.....	1
2	Introduction	2
3	Safety	3
3.1	General Safety Information	3
3.2	Safety Terms Used In This Manual	3
3.3	Warning and Caution Statements	3
3.4	UL Listing Note	4
3.5	International Electrical Symbols	4
3.6	CENELEC Directives.....	5
4	Descriptions	6
4.1	Product Description.....	6
4.2	Control Button Descriptions	7
4.3	Rotary Switch Positions.....	7
4.4	Display Description	8
5	Meter Operation	9
5.1	Powering the Meter	9
5.2	Auto Power OFF (APO).....	9
5.3	Automatic and Manual Ranges	9
5.4	Out-of-Range Alert.....	10
5.5	Display Hold Function.....	10
5.6	Display Backlight	10
5.7	Voltage Measurements	10
5.8	LoZ Voltage Measurements	11
5.9	Low Pass Filter (VFD) Voltage Measurements.....	12
5.10	Milli-Volt Measurements	12
5.11	Current Measurements (Clamp).....	13
5.12	Resistance Measurements	15
5.13	Continuity Measurements.....	16
5.14	Diode Measurements	17
5.15	Type-K Thermocouple Measurements.....	18
5.16	External Clamp Adaptor Current Measurements.....	20

Table of contents

6	Bluetooth® Communication and FLIR Tools™	21
6.1	FCC Compliance	21
7	Function Icons	23
8	Programming Menu	26
9	Data Logging	28
9.1	Data Logging Basics	28
9.2	Start/Stop a Data logging session.....	28
9.3	Deleting Data Log Files	28
9.4	Transmitting Data Log Files to a Mobile Device.....	28
9.5	Transferring Data Log Files to a PC.....	28
9.6	Viewing Data Log File Contents on the CM65 Display	28
10	USB Connectivity	29
10.1	Field Firmware Updates	29
10.2	Transferring Data Log Files to PC	29
11	Maintenance	30
11.1	Cleaning	30
11.2	Battery Replacement	30
11.3	Meter Storage	30
12	Specifications	31
12.1	General Specifications	31
12.2	DC Voltage Specifications	32
12.3	DC mV Specifications	32
12.4	AC Voltage Specifications	32
12.5	AC mV Specifications	32
12.6	VFD AC Voltage Specifications	32
12.7	LoZ Voltage AC and DC Specifications	33
12.8	Frequency Specifications	33
12.9	DC Current Specifications (Clamp)	33
12.10	AC Current Specifications (Clamp)	33
12.11	Resistance Specifications	34
12.12	Continuity Specifications	34
12.13	Diode Specifications	34
12.14	External (Flex) Clamp Adaptor — AC Current Specifications	34
12.15	Temperature Specifications.....	35

Table of contents

12.16 Input Specifications 35

12.17 Safety Specifications 35

13 Three-Year Warranty 37

14 Customer Support 38

14.1 Corporate Headquarters 38

1 Advisories

1.1 Copyright

©2021, FLIR Systems, Inc. All rights reserved worldwide. No parts of the software including source code may be reproduced, transmitted, transcribed or translated into any language or computer language in any form or by any means, electronic, magnetic, optical, manual or otherwise, without the prior written permission of FLIR Systems.

The documentation must not, in whole or part, be copied, photocopied, reproduced, translated or transmitted to any electronic medium or machine-readable form without prior consent, in writing, from FLIR Systems. Names and marks appearing on the products herein are either registered trademarks or trademarks of FLIR Systems and/or its subsidiaries. All other trademarks, trade names or company names referenced herein are used for identification only and are the property of their respective owners.

1.2 Quality Assurance

The Quality Management System under which these products are developed and manufactured has been certified in accordance with the ISO 9001 standard.

FLIR Systems is committed to a policy of continuous development; therefore, we reserve the right to make changes and improvements on any of the products without prior notice.

1.3 Documentation

To access the latest manuals and notifications, go to the Download tab at: <https://support.flir.com>. It only takes a few minutes to register online. In the download area you will also find the latest releases of manuals for our other products, as well as manuals for our historical and obsolete products.

1.4 Disposal of Electronic Waste



As with most electronic products, this equipment must be disposed of in an environmentally friendly way, and in accordance with existing regulations for electronic waste. Please contact your FLIR Systems representative for more details.

2 Introduction

The CM65 is a 600 A True RMS Clamp Meter designed to meet the challenges of the solar, alternative/renewable energies, and utilities industries. The supplied MC4 test leads help you troubleshoot photovoltaic systems and keep them running efficiently. The CM65 accurately measures voltage, current and other electrical parameters to ensure proper installation of PV systems. FLIR's exclusive METERLiNK® technology wirelessly connects to FLIR Tools® Mobile so you can view readings and receive data log files from the CM65 on your mobile device. The CM65 is the perfect tool for the installation and maintenance of photovoltaic systems and includes features and accessories optimized for residential and light commercial electricians, and RV technicians.

Visit <https://www.support.flir.com/prodreg> to register your CM65 and to read the three-year warranty text.

Features

- 6000 count digital backlit display
- 1000 V AC/DC test lead measurements
- 600 A AC/DC clamp measurements
- Frequency reading for AC Current/Voltage measurements
- Resistance measurements to 60 k ohms
- Continuity and Diode measurements
- Type-K thermocouple temperature measurements
- External clamp adaptor measurements
- Display Hold
- DC zero adjust
- Minimum/Maximum/Average recording memory
- Integrated VFD mode (low-pass filter) on AC V and Hz measurements
- LoZ (low impedance) mode eliminates 'ghost' voltage problems
- Bluetooth® connectivity for remote measurement monitoring and data log file transmit
- USB port in battery compartment for field firmware updates and data log file transfer
- Adjustable Auto power OFF (APO) timer
- Safety Category Rating: CAT III 1000 V & CAT IV 600 V AC & DC

3 Safety

3.1 General Safety Information

This user manual contains information and warnings that must be followed for operating the instrument safely and maintaining the instrument in a safe operating condition. If the instrument is used in a manner not specified by the manufacturer, the protection provided by the instrument may be impaired.



The meter protection rating, against the users, is double insulation per UL/IEC/EN61010-1 Ed. 3.0, IEC/EN61010-2-033 Ed. 1.0, CAN/CSA C22.2 No. 61010-1 Ed. 3.0, IEC/EN61010-2-032 Ed. 3.0 & IEC/EN61010-031 Ed. 1.1: Measurement Category III 1000V & Category IV 600V AC & DC.







3.2 Safety Terms Used In This Manual

WARNING: Identifies conditions and actions that could result in serious injury or even death to the user.

CAUTION: Identifies conditions and actions that could cause damage or malfunction in the instrument.

3.3 Warning and Caution Statements

	WARNING
To reduce the risk of fire or electric shock, do not expose this product to rain or moisture. The meter is intended only for indoor use.	
	WARNING
To avoid electrical shock hazard, observe the proper safety precautions when working with voltages above 60 V DC or 30 V AC rms. These voltage levels pose a potential shock hazard to the user. Before and after hazardous voltage measurements, test the voltage function on a known source such as line voltage to determine proper meter functioning.	
	WARNING
Keep hands/fingers behind the hand/finger barriers (of the meter and the test leads) during measurement. Inspect test leads, connectors, and probes for damaged insulation or exposed metal before using the instrument. If any defects are found, replace them immediately. Use only the test leads provided with the equipment (or UL Listed probe assemblies rated CAT III 1000 V or better).	

	WARNING
<p>The accompanied test probe assembly meets UL/IEC/EN61010-031 Ed. 1.1 to 10A maximum at 140°F (60°C). IEC 61010-031 requires exposed conductive test probe tips to be ≤ 4 mm for CAT III & CAT IV ratings. Refer to the category markings on your probe assemblies as well as on the add-on accessories (detachable Caps or Alligator Clips, etc.), if any, for applicable rating changes.</p>	
	WARNING
<p>This Clamp meter is designed for clamping around or removing from non-insulated, hazardous live conductors. Nonetheless, individual protective equipment must be used when hazardous live parts in the installation, where the measurement is to be made, could be accessible.</p>	
	WARNING
<p>Remove test leads from the meter before taking clamp measurements.</p>	
	CAUTION
<p>The maximum current rating for the supplied MC4 test leads is 10 A at 140°F (60°C) maximum.</p>	
	CAUTION
<p>Disconnect the test leads from the test points before changing meter functions.</p>	
	CAUTION
<p>Do not use the device for a procedure that it is not intended for. This can cause damage to the protection built into the instrument.</p>	

3.4 UL Listing Note

UL listing is not an indication or a verification of the accuracy of the meter

3.5 International Electrical Symbols

 Caution! Refer to the explanation in the user manual.

 Caution! Risk of electrical shock.

 Earth ground.

 Double/reinforced insulation.

 Fuse.

 AC (alternating current).

 DC (direct current).

 Application around, and removal from, hazardous live conductors is permitted.

3.6 CENELEC Directives

This instrument conforms to CENELEC Low-voltage directive 2014/35/EC, Electromagnetic compatibility directive 2014/30/EU and RoHS directive 2011/65/EU.

4 Descriptions

4.1 Product Description

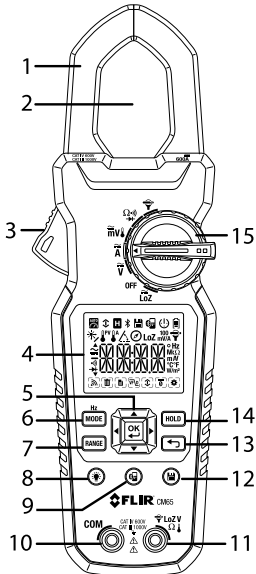







Figure 4.1 Product Description





1. Clamp jaws
2. Clamp measurement area
3. Jaw opening trigger
4. Display area
5. *OK* menu button (center) and navigation arrows
6. *MODE*/*Hz* button
7. *RANGE* button
8. Display backlight button
9. Bluetooth® *ON/OFF* button
10. *COM* (-) test lead terminal
11. Positive (+) test lead terminal
12. *Data log* button
13. *Return* button (back up and exit menu)
14. *HOLD* button
15. Rotary function selector

Note: Battery compartment on rear, not pictured. USB port located inside battery compartment.

4.2 Control Button Descriptions

MODE Hz	Toggle AC/DC (short presses), select frequency (Hz) mode (long press), select an option at a multi-option rotary switch position.
RANGE	Short press for Manual range mode, long press to return to Auto.
HOLD	Short press to freeze/unfreeze displayed readings.
	Return button, short press to back up or exit the menu system.
OK 	Short press to open a menu and to confirm selections.
	Navigation buttons (short presses).
	Short press to toggle display backlight ON/OFF.
	Short press to toggle Bluetooth® ON/OFF.
	Short press to start/stop the data logger.

4.3 Rotary Switch Positions

LoZ	Low Impedance mode.
OFF	Meter power is switched OFF.
V	Voltage mode (AC/DC).
A	Current mode (AC/DC).
mV	Millivolt mode (AC/DC).
	Thermocouple measurement mode.
Ω	Resistance mode.
	Continuity mode.
	Diode mode.
	External clamp meter adaptor mode.

4.4 Display Description

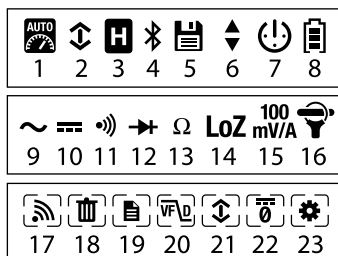

Figure 4.2 Display Icon Descriptions

1. Auto Range
2. MAX/MIN/AVG memory
3. Data Hold
4. Bluetooth®
5. Data logger
6. Prompt to use up/down arrow buttons
7. Auto Power OFF (APO)
8. Battery status
9. AC measurements
10. DC measurements
11. Continuity function
12. Diode function
13. Resistance function (ohms)
14. Low Impedance mode
15. External clamp adaptor range
16. External clamp adaptor mode
17. Data Log File transmit function icon
18. Data Log File delete function icon
19. Data Log File open function icon
20. Low pass filter function icon
21. MAX/MIN/AVG function icon
22. DC Zero function icon
23. Settings function icon (opens Programming Menu)



NOTE

Not all icons are represented in Figure 4–2. Other available icons are explained in their respective sections of this user manual.

5 Meter Operation



CAUTION

Before operating the device, you must read, understand, and follow all instructions, dangers, warnings, cautions, and notes.

NOTE

When the meter is not in use, the function switch should be set to the OFF position.



CAUTION

When connecting the probe leads to the device under test, connect the negative lead before connecting the positive lead. When removing the probe leads, remove the positive lead before removing the negative lead.



CAUTION

Before and after hazardous voltage measurements, test the voltage function on a known source (such as line voltage) to determine proper meter functionality.

5.1 Powering the Meter

Set the function switch to any position to power the meter ON.

If the low battery voltage warning is displayed, or if the meter does not power ON, replace the batteries. See Section 11, *Maintenance*, for battery replacement details.

5.2 Auto Power OFF (APO)

The APO feature switches the meter OFF after approximately 10 minutes (default) of inactivity. The APO timer can be set from 1 to 99 minutes (see the Programming Menu section). The meter will beep to alert you when it is about to power OFF, press any button to extend the APO time before it powers OFF.

5.3 Automatic and Manual Ranges

The meter uses automatic ranging by default. To manually select a measurement range, short press the RANGE button to exit the Auto mode. Subsequent, short presses will step through the available ranges. Long press the RANGE button to return to the Auto Range mode. When the Auto Range mode is active, the Auto Range symbol is displayed. In the manual mode, the meter may display an up arrow, suggesting that a higher range should be selected for best accuracy and resolution.



Figure 5.1 Auto Range Display Icon

5.4 Out-of-Range Alert

If the input is out-of-range, **OL** is displayed. Please do not attempt to make measurements beyond the specified ranges of the meter.

5.5 Display Hold Function

After taking a measurement, short press the HOLD button to freeze a reading. Press the HOLD button again to return to normal operation. The **H** icon will appear when the display hold function is engaged.

5.6 Display Backlight

Short press the backlight button  to turn ON the display backlighting. Press again to switch the backlight OFF.

5.7 Voltage Measurements

	CAUTION
Use caution when the measured voltage is greater than 30V DC or AC rms.	

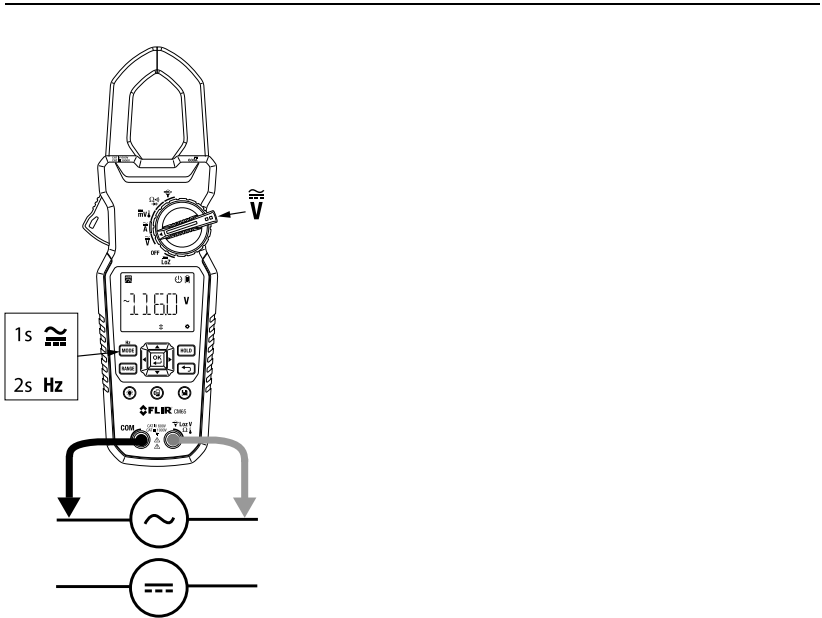



Figure 5.2 Basic Voltage Measurement Setup

1. Set the function switch to the Voltage position \bar{V} .
2. Short press the MODE button to select AC or DC voltage mode.
3. Insert the black test lead into the negative (COM) terminal and the red test lead into the positive terminal.
4. Place the probe ends of the test leads in parallel to the part under test.
5. Read the Auto Range voltage measurement on the display.
6. To switch to Manual Range mode, short press the RANGE button. Subsequent short presses of the RANGE button will step through the available ranges. Long press the RANGE button to return to Auto Range mode.
7. Long press the MODE button to read the frequency (Hz) of an AC signal.
8. The available Function Icons in Voltage mode are Settings, MIN/MAX/AVG, and VFD (AC only). See Section 7, *Function Icons*, for complete details.

5.8 LoZ Voltage Measurements

	CAUTION
Use caution when the measured voltage is greater than 30V DC or AC rms.	

LoZ Voltage measurements eliminate the affects of 'ghost' voltages. The procedure for taking LoZ Voltage measurements is virtually the same as for taking standard Voltage measurements, the only difference is that for LoZ Voltage measurements you select the LoZ rotary switch position. Note that frequency (Hz) measurements are not available in LoZ Voltage mode. Refer to Section 5.7, *Voltage Measurements*, for other voltage measurement details.

5.9 Low Pass Filter (VFD) Voltage Measurements



CAUTION

Use caution when the measured voltage is greater than 30V DC or AC rms.

The VFD feature in the CM65 eliminates high frequency noise in AC voltage measurements by means of a low pass filter. The VFD mode is designed for variable frequency drive measurements. When taking AC Voltage measurements, the VFD function icon will appear on the bottom of the display. Scroll to the icon with the arrow buttons and press the OK button to engage the VFD mode. Press the Return button to disengage the mode (see Section 7, *Function Icons*, for complete details). The procedure for taking VFD Voltage measurements is identical to the procedure for taking standard Voltage measurements. Refer to Section 5.7, *Voltage Measurements*, for additional voltage measurement details.

5.10 Milli-Volt Measurements



CAUTION

Use caution when the measured voltage is greater than 30V DC or AC rms.

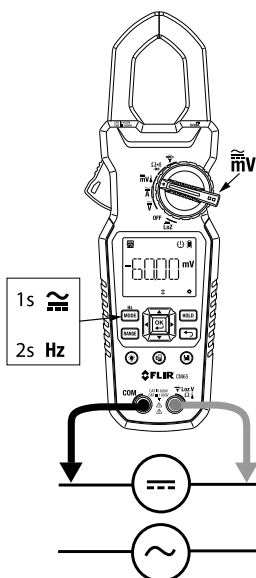

Figure 5.3 Millivolt Measurements



1. Set the function switch to the millivolt position \tilde{mV} .
2. Short press the MODE button to select AC or DC voltage mode.
3. Insert the black test lead into the negative (COM) terminal and the red test lead into the positive terminal.
4. Place the probe ends of the test leads in parallel to the part under test.
5. Read the Auto Range voltage measurement on the display.
6. To switch to Manual Range mode, short press the RANGE button. Subsequent short presses of the RANGE button will step through the available ranges. Long press the RANGE button to return to Auto Range mode.
7. Long press the MODE button to read the frequency (Hz) of an AC signal.
8. The available Function Icons in the millivolt mode are Settings and MIN/MAX/AVG. See Section 7, *Function Icons*, for complete details.

5.11 Current Measurements (Clamp)



WARNING

Do not measure current on a circuit if the voltage increases to more than 1000 V. This can cause damage to the instrument and can cause injury to persons.

	WARNING
Do not use the meter to measure current above the rated frequency. This may cause the magnetic circuits in the jaws to reach hazardous temperatures.	
	WARNING
Disconnect the test leads from the meter before taking Clamp measurements.	

Clamp Measurement Considerations

- Press the jaw trigger to open the jaws and then clamp around the conductor(s) of only one pole of a circuit.
- Ensure that the jaws are completely closed. Enclosing conductor(s) of more than one pole of a circuit may result in differential current measurements.
- Align the conductor(s) to the jaws center indicators as closely as possible.
- Adjacent current-carrying devices such as transformers, motors and conductor wires may affect measurement accuracy.

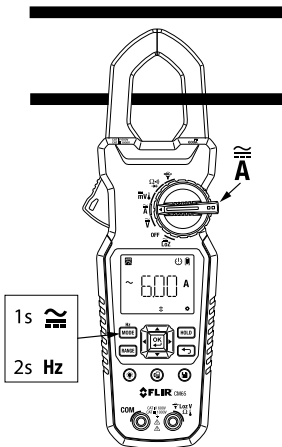



Figure 5.4 Basic Current Clamp Measurement

Taking Current Clamp Measurements

1. Set the function switch to the Ampere position .

2. Short press the MODE button to select AC or DC current mode.
3. For DC current mode, with no conductor in the clamp, use the DC Zero menu icon to zero the display (see the Function Icons section for complete details).
4. Press the trigger to open the clamp jaws and clamp around the conductor under test.
5. Read the Auto Range current measurement on the display.
6. To switch to Manual Range mode, short press the RANGE button. Subsequent short presses of the RANGE button will step through the available ranges. Long press the RANGE button to return to Auto Range mode.
7. Long press the MODE button to read the frequency (Hz) of an AC signal.
8. The available Function Icons in the Current mode are Settings, MIN/MAX/AVG, and DC Zero (DC only). See Section 7, *Function Icons*, for complete details.

5.12 Resistance Measurements



WARNING

Do not take resistance measurements before removing power to the resistor or circuit under test. Injury to persons can occur.

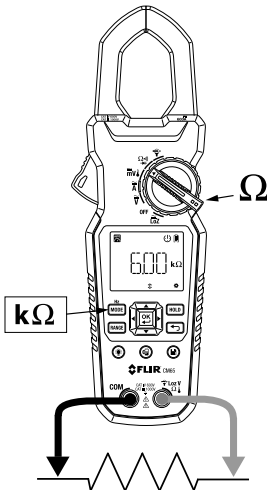



Figure 5.5 Resistance Measurements

1. Set the function switch to the Resistance position Ω .

2. If necessary, short press the MODE button to select the Resistance function $k\Omega$.
3. Insert the black test lead into the negative (COM) terminal and the red test lead into the positive terminal.
4. Place the probe ends of the test leads in parallel to the part under test.
5. Read the resistance value on the display.
6. To switch to Manual Range mode, short press the RANGE button. Subsequent short presses of the RANGE button will step through the available ranges. Long press the RANGE button to return to Auto Range mode.
7. The available Function Icons in the Resistance mode are Settings and MIN/MAX/AVG. See Section 7, *Function Icons*, for complete details.

5.13 Continuity Measurements

	WARNING
<p>Do not perform continuity tests before removing power to the device under test. Injury to persons can occur.</p>	

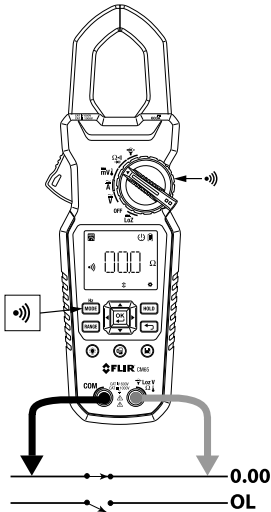



Figure 5.6 Continuity Measurements (note the OPEN and the SHORTED wire examples)

1. Set the function switch to the Continuity position .
2. If necessary, short press the MODE button to select the Continuity function.

3. Insert the black test lead into the negative (COM) terminal and the red test lead into the positive terminal.
4. Place the probe ends of the test leads in parallel to the part under test.
5. If the measurement is $<30\ \Omega$, the meter will beep. If the measurement is $>480\ \Omega$, the meter will not beep. Between $30\ \Omega$ and $480\ \Omega$, the meter will stop beeping at an unspecified point.
6. The available Function Icons in the Continuity mode are Settings and MIN/MAX/AVG. See Section 7, *Function Icons*, for complete details.

5.14 Diode Measurements



WARNING

Do not perform diode tests before removing power to the diode under test. Injury to persons can occur.

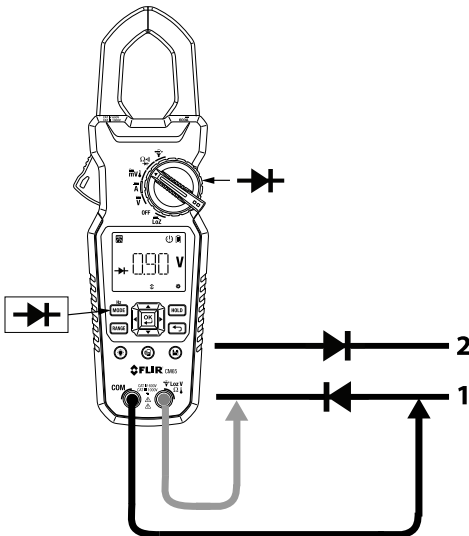

Figure 5.7 Basic Diode Test Setup (Note Test 1 and Test 2 examples)

1. Set the function switch to the Diode position $\rightarrow| \leftarrow$.
2. If necessary, short press the MODE button to select the Diode function.
3. Insert the black test lead into the negative (COM) terminal and the red test lead into the positive terminal.

4. Take two diode measurements, one in forward bias and one in reverse bias. This can be accomplished by, first, placing the probe ends of the test leads in parallel to the part under test in one direction and then taking a second measurement in the reverse polarity orientation.
5. If the reading is between 0.40 V and 0.90 V in one direction and OL (overload) in the opposite direction, the component is good. If the measurement is 0V in both directions (shorted) or OL in both directions (open), the component is bad.
6. The available Function Icons in the Diode mode are Settings and MIN/MAX/AVG. See Section 7, *Function Icons*, for complete details.

5.15 Type-K Thermocouple Measurements



CAUTION

The supplied thermocouple is rated for -4~482°F (-20~250°C) only, it is not rated for the entire specified temperature range of the meter.

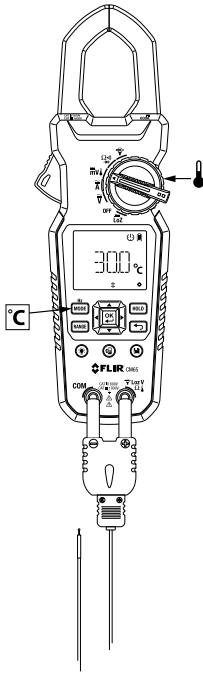



Figure 5.8 Thermocouple Temperature Measurements

1. Set the function switch to the Temperature position .
2. Use the MODE button to select the Temperature mode.
3. Insert the banana plug Type-K temperature probe into the meter's input terminals observing correct polarity. A plug adapter with banana plug to Type-K socket (to adapt to other Type-K standard mini plug temperature probes) can be obtained optionally.
4. Touch the thermocouple probe tip to the surface of an object under test or hold the probe in air.
5. Read the temperature measurement on the display.
6. To select °C or °F as the default unit of measure, see Section 8, *Programming Menu*.
7. The available Function Icons in Temperature mode are Settings and MIN/MAX/AVG. See Section 7, *Function Icons*, for complete details.

5.16 External Clamp Adaptor Current Measurements

Note: This section applies only to measurements taken with an external clamp adaptor that connects to the CM65 input terminal jacks. For clamp measurements using the CM65's built-in clamp jaws, please see Section 5.11, *Current Measurements (Clamp)*.

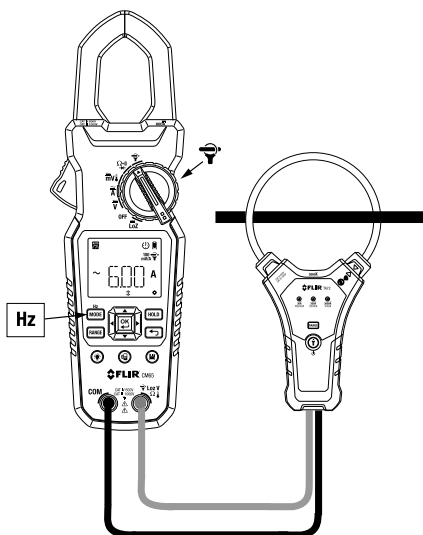



Figure 5.9 External Clamp Adaptor Test Setup

1. Set the CM65 function switch to the external clamp adaptor position .
2. Connect the external clamp adaptor to the CM65 by inserting the signal leads from the external clamp to the input terminals on the CM65, observing correct polarity.
3. Press the trigger to open the clamp jaws on the external clamp adaptor and clamp around the conductor under test.
4. Read the measurement on the CM65 display. See Section 12.15, *External Clamp Adaptor (AC Current)*, to help interpret the reading based on the range of the measurement. As an example, in some ranges, for each 100mV sent to the CM65 by the external clamp adaptor, the CM65 displays 1 ampere (100mV/A).
5. The available Function Icons in this mode are Settings and MIN/MAX/AVG. See Section 7, *Function Icons*, for complete details.

6 Bluetooth® Communication and FLIR Tools™

To connect the CM65 to a mobile device running the FLIR Tools™ Mobile App, turn on the mobile device and start the FLIR Tools™ Mobile App (download the mobile App from the Google Play™ store, the Apple App store, or here: <https://www.flir.com/products/flir-tools-app/>).

Select INSTRUMENTS from the drop-down menu in the App and search for the CM65 (the CM65 must be ON and the Bluetooth® button must be pressed so that the Bluetooth® icon is displayed on the CM65). Tap in the App to connect to the CM65.

When connected to a device running the App, the CM65 (using the METER-LiNK® protocol) continually sends readings for live display on the remote device. The CM65 can also transmit bulk data log files to a mobile device (see Section 9, *Data logging*, and Section 7, *Function Icons*, to learn about these features).

6.1 FCC Compliance

This device complies with part 15 of the FCC Rules. Operation is subject to the following two conditions:

1. This device may not cause harmful interference.
2. This device must accept any interference received, including interference that may cause undesired operation.

This equipment has been tested and found to comply with the limits for a Class B digital device, pursuant to part 15 of the FCC Rules. These limits are designed to provide reasonable protection against harmful interference in a residential installation. This equipment generates, uses, and can radiate radio frequency energy and, if not installed and used in accordance with the instructions, may cause harmful interference to radio communications. However, there is no guarantee that interference will not occur in a particular installation. If this equipment does cause harmful interference to radio or television reception, which can be determined by turning the equipment off and on, the user is encouraged to try to correct the interference by one or more of the following measures:

1. Reorient or relocate the receiving antenna.
2. Increase the separation between the equipment and receiver.

3. Connect the equipment into an outlet on a circuit different from that to which the receiver is connected.
4. Consult the dealer or an experienced radio/TV technician for help.

**WARNING**



Changes or modifications not expressly approved by the party responsible for compliance could void the user's authority to operate the equipment.

7 Function Icons







Figure 7.1 The Seven Function Icons (bottom of display)

The CM65 has seven Function Icons that appear along the bottom row of the display in a variety of combinations depending on the selected function. The seven icons are shown in the display description section of this manual and are explained below. To enable a Function Icon, scroll to it with the left/right arrow buttons. When you've reached it, it will begin blinking. Press the OK button to enable it, a box will appear around the icon indicating that it has been enabled. To disable it, press the Return button, the box will disappear.

- **Data Log File Transmit** 
 1. Once a data log file is created (see Section 9, *Data Logging*, to create a file), open the Programming Menu (press OK) and scroll to the FILE parameter. See Section 8, *Programming Menu*, for more details.
 2. When you press OK at the FILE parameter in the Programming Menu, a data log list will be available. Scroll through the list and press OK at the desired log to select it.
 3. With the CM65 paired with a mobile device (see Section 6, *Bluetooth® Communications and FLIR Tools™*), press the Data Log File Transmit icon (see icon at beginning of this section) to transmit the log file to the mobile device.
- **Data Log File Delete** 
 1. To create a data log file, see Section 9, *Data Logging*.
 2. Once a data log file is created, press OK to open the Programming Menu and scroll to the FILE parameter. Press OK at the FILE parameter to open it. See Section 8, *Programming Menu*, for more information.
 3. When you open the FILE parameter in the Programming Menu a data log list will be available. Scroll to the desired log and press OK.
 4. Scroll to the Data Log File Delete icon (bottom of display) and press OK, this will erase the selected file (see icon at the beginning of this section).
- **Data Log File Open** 



To view the logged readings of a file directly on the CM65 display, see the steps below:

-
1. Press OK to open the Programming Menu
 2. Scroll to the FILE parameter in the menu
 3. Scroll to the desired data log file (they are serially numbered)
 4. With the desired data log file number displayed, press OK.
 5. Scroll to the Data Log File Open function icon at the bottom of the display  and press OK. See Section 8, *Programming Menu*, for additional details.
 6. The data log file is now open, you can scroll through the data using the arrow buttons. The display will prompt you with arrow symbols indicating which arrow buttons are available for use. Note that the file provides date and time along with the measurement readings.
 7. Press the Return button to return to the Programming. Press the Return button again to exit the menu.
- **Low Pass Filter** 
 1. This icon appears when you've selected the AC Voltage mode of operation. See Section 5.9, *Low Pass Filter*, for additional information.
 2. With the AC Voltage mode selected, you'll see the VFD icon at the bottom of the display, scroll to it with the left/right arrow buttons. When the icon is blinking, press the OK button to activate the VFD mode (a box will appear around the icon). To disengage the VFD mode, press the Return button (the box will disappear).
 - **Max/Min/Avg** 
 1. This icon is available in most measurement modes. When selected, the CM65 records the maximum, minimum, and average readings.
 2. When this icon is available, scroll to it with the left/right arrow buttons until the icon is blinking.
 3. Press OK at the blinking icon to engage the Max/Min/Avg mode.
 4. Use the up/down arrow buttons to scroll through the Max (up arrow symbol), Min (down arrow symbol), Average (up and down arrow symbol) and real time reading (no arrow symbols).
 5. To exit this mode (and to reset the Max/Min/Avg memories), press the Return button.
 - **DC Zero** 
 1. This icon is available in the DC current mode. When selected, the CM65 display zeros so you can take an accurate DC clamp meter measurement.

2. When this icon is available, scroll to it with the left/right arrow buttons until the icon is blinking.
 3. Press OK at the blinking icon to engage the mode and the display will zero.
 4. To exit this mode, press the Return button.
- **Settings (to access Programming Menu)** 
 1. The Settings function icon takes you to the Programming Menu. See Section 8, *Programming Menu*, for complete details.

8 Programming Menu

To access the CM65 Programming Menu, short press the OK button with the meter ON (or select the Settings function icon as explained in Section 7, *Function Icons*). Use the up/down arrow buttons to scroll the Programming Menu list and press OK at a parameter to open it. See the details below:

- **APO:** Auto Power OFF utility.
 1. Press OK at the APO parameter to open it.
 2. Use the up/down arrow buttons to change the value of the flashing digit.
 3. Use the left/right arrows to select a digit for editing and use the up/down arrows to change it. The APO setting range is OFF (no APO function) and 1 to 99 minutes.
 4. Press OK to confirm the new APO time.
 5. Use the up/down arrows to select a new parameter to edit, or press the Return button to exit to the normal operating mode.
- **FILE:** Data Log file list.
 1. Press OK at the FILE parameter to open it. If Data Log records are saved, the list will appear here.
 2. Use the up/down arrows to scroll through the data log list.
 3. Press OK at a list to open it.
 4. When a list is open, the Function Icons for *file delete* , *file transmit* , and *file open*  will appear on the bottom of the display. Note that the file transmit icon will only appear if Bluetooth® is enabled in this Programming Menu (BLE), the Bluetooth® button is pressed so that the Bluetooth® icon is shown on the CM65 display, and the CM65 is paired with a mobile device. For details, see Section 6 for *Bluetooth®* and Section 7 for *Function Icons*.
 5. Press the Return button to return to the main menu list. Press again to return to the normal operating mode or use the arrows to select another menu parameter.
- **TIME:** Set the date and time.
 1. Press OK at the TIME parameter to open it.
 2. Use the up/down arrows to set the year.
 3. Press OK to confirm.
 4. Use the up/down arrows to set the month.
 5. Use the right arrow to move to the date digits, use the up/down arrows to set the date.

6. Press OK to confirm the month and date.
 7. Use the up/down arrows to set the hours.
 8. Use the right arrow to select the minutes digits and use the up/down arrows to set the minutes.
 9. Press OK to confirm the hours and minutes.
 10. Use the up/down arrows to select a new parameter to edit, or press Return to exit to the normal operating mode.
- **BLE:** Bluetooth® enable/disable.
 1. Press OK at the BLE parameter.
 2. Use the up/down arrows to select ON or OFF.
 3. Press OK to confirm setting.
 4. Use the up/down arrows to select a new parameter to edit, or press Return to exit to the normal operating mode.
 - **TEMP:** Select the temperature units of measure.
 1. Press OK at the TEMP parameter.
 2. Use the up or down arrow button to select °C or °F.
 3. Press OK to confirm.
 4. Use the up/down arrows to select a new parameter to edit, or press Return to exit to the normal operating mode.
 - **RST:** Factory Default Reset.
 1. Press OK at the RST parameter.
 2. Use the up or down arrow to select YES or NO.
 3. Press OK to confirm.
 4. Use the up/down arrows to select a new parameter to edit, or press Return to exit to the normal operating mode.

9 Data Logging

9.1 Data Logging Basics

The CM65 data logging utility allows you to automatically log readings to an internal file every 10 seconds. Each file can contain up to 9999 readings and the maximum number of files that can be created is 999. Files are automatically serially numbered. Each time a data log session is opened and closed, a new file is created.

9.2 Start/Stop a Data logging session

Short press the Data log button to start a data logging session. Readings will be stored every 10 seconds. The data log icon will appear at the top of the CM65 display while the meter is logging. To stop the session, press the data log button again (the data log icon will disappear).



Figure 9.1 Data Log Start/Stop button and display icon.

9.3 Deleting Data Log Files

To delete a Data log file, use the Data Log Delete function icon . Please see Section 7, *Function Icons*, for complete details.

9.4 Transmitting Data Log Files to a Mobile Device

The CM65 can transmit Data Log files to a paired mobile device using the Data Log File Transmit function icon . Please read the paragraph *Data Log File Transmit* in Section 7, *Function Icons*, for complete details. See also Section 6, *Bluetooth®*, and Section 8, *Programming Menu*, for more information.

9.5 Transferring Data Log Files to a PC

The CM65 includes a USB port in the battery compartment for connecting with a PC. See Section 10, *USB connectivity*, for details.

9.6 Viewing Data Log File Contents on the CM65 Display

For complete instructions on viewing data log file data directly on the CM65 display, please see Section 7, *Function icons* and read the *Data Log File Open* paragraph.

10 USB Connectivity

10.1 Field Firmware Updates

The USB port in the battery compartment allows for field firmware updates, follow the steps below.

1. Connect the CM65 to a PC using a USB cable. The CM65 USB port is located in the battery compartment.
2. Turn the CM65 rotary switch to any position, the CM65 will display 'USB'.
3. Download the update file (CM65_V0.0x.hex) from the FLIR support site (<https://support.flir.com>) and transfer it to the CM65 internal memory root directory.
4. **IMPORTANT:** Disconnect the CM65 from the PC. Do not proceed unless the USB cable that connects the CM65 to the PC is disconnected.
5. Turn the CM65 rotary switch to the OFF position.
6. Turn the CM65 rotary switch to any ON position.
7. The CM65 will begin the update process. This will take approximately 30 seconds during which there will be a blank screen.
8. When the update is complete, the CM65 will emit an alert beep and will reboot.
9. This completes the update process, if errors occur please contact FLIR customer support.

10.2 Transferring Data Log Files to PC

The USB port in the battery compartment allows for Data Log File transfer. Connect the CM65 to a PC USB port and use the CM65 as you would any external storage device. For information on data logging, see Section 9, *Data Logging*.

11 Maintenance

11.1 Cleaning

With the CM65 OFF, wipe the meter housing with a damp cloth as needed. Do not use abrasives or solvents. Dry completely before use.

11.2 Battery Replacement

The battery compartment is located on the back of the CM65. Use a small screwdriver to turn the battery compartment lock so that the arrow printed on the battery compartment cover is pointing toward the 'open lock' icon. Open the compartment and replace the three 'AA' batteries observing correct polarity. Please secure the battery compartment before using the meter.

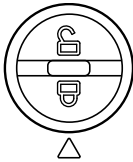

Figure 11.1 Battery Compartment Lock.

11.3 Meter Storage

If the meter is to be stored for an extended period, please remove the batteries for safety.

12 Specifications

12.1 General Specifications

Display	6000 count backlit LCD
Polarity	Automatic
Update rate	5 readings per second, nominal
Operating temperature	32 ~ 140°F (0 ~ 60°C)
Relative humidity	Maximum relative humidity 80% for temperature up to 88°F (31°C) decreasing linearly to 50% relative humidity at 122°F (50°C)
Pollution	Degree 2
Storage temperature	-4 ~ 140°F (-20 ~ 60°C) < 80% RH (with battery removed)
Operating altitude	7000 ft. (2000 m) maximum
Temperature coefficient	Nominal 0.15 x (specified accuracy)/ °C @ 32 ~ 64.4°F [0 ~ 18°C] or 82.4 ~ 122°F [28 ~ 50°C]), or as otherwise specified
Sensing	True RMS
Transient protection	6.0 kV (1.2/50µs surge)
Power supply	1.5 V 'AA' battery x 3
Power consumption	90 mA for all DMM functions with backlight OFF
APO timer	10 minutes (default). Adjustable from 1 to 99 minutes
Dimensions	(LxWxH): 9.9 x 3.4 x 1.6 in. (251 x 86 x 41 mm)
Weight	10.6 oz. (300 g)
Jaw opening/Conductor diameter	1.2 in. (30 mm) maximum
Electrical specification accuracy	± (% reading + number of digits) or as otherwise specified, at 73.4°F (23°C) ± 9°F (5°C)

12.2 DC Voltage Specifications

Range and Resolution	Accuracy
60.00 V	± (1% + 2 digits)
600.0 V	
1000 V	

Input Impedance: 10MΩ, 100 pF nominal

Safety Category Rating: CAT III 1000 V & CAT IV 600 V DC

12.3 DC mV Specifications

Range and Resolution	Accuracy
60.00 mV	± (1% + 2 digits)
600.0 mV	

12.4 AC Voltage Specifications

Range and Resolution	Frequency	Accuracy
60.00 V / 600.0 V / 1000 V	50Hz ~ 60 Hz	± (0.7% + 3 digits)
	45Hz ~ 440 Hz	± (2.0% + 3 digits)

Input Impedance: 10MΩ, 100 pF nominal

Safety Category Rating: CAT III 1000 V & CAT IV 600 V AC

12.5 AC mV Specifications

Range and Resolution	Frequency	Accuracy
60.00 mV / 600.0 mV	50Hz ~ 60 Hz	± (1.0% + 3 digits)
	10Hz ~ 500 Hz	± (2.0% + 3 digits)

12.6 VFD AC Voltage Specifications

Range and Resolution	Frequency	Accuracy
60.00 V / 600.0 V / 1000 V	10Hz ~ 100 Hz	± (1.0% + 3 digits)
	100Hz ~ 440 Hz	± (10.0% + 3 digits)

12.7 LoZ Voltage AC and DC Specifications

Range and Resolution	Frequency	Accuracy
60.00 V /600.0 V /1000 V	45Hz ~ 440Hz	± (2.0% + 3 digits)

For inputs < 50 V, the impedance is 2.3 kΩ. For inputs > 50 V, the initial impedance is 2.3 kΩ increasing to 1 MΩ at 1000V.

12.8 Frequency Specifications

Ranges	Sensitivity	Frequency
60 mV, 600 mV	50 mV	10 Hz ~ 50 kHz
60 V	10 V	10 Hz ~ 50 kHz
600 V	50 V	10 Hz ~ 1 kHz
1000 V	500 V	10 Hz ~ 1 kHz
600 V (VFD)	50 V	10 Hz ~ 400 Hz
1000 V (VFD)	500 V	10 Hz ~ 400 Hz
60 A, 600 A	50 A	50 Hz ~ 400 Hz

Accuracy: ± (0.03% + 2 digits)

12.9 DC Current Specifications (Clamp)

Range	Resolution	Accuracy
60.00 A	0.01 A	± (1.5% + 5 digits)
600.0 A	0.1 A	± (2.0% + 5 digits)

Safety Category Rating: CAT III 1000 V & CAT IV 600 V DC

Induced error from adjacent current-carrying conductors: <0.01A/A

Accuracy specified with DC Zero mode applied to offset non-zero residual readings

Add 10 digits to the specified accuracy @ < 9 A

12.10 AC Current Specifications (Clamp)

Range	Resolution	Frequency	Accuracy
60.00 A	0.01 A	50 ~ 100 Hz	± (1.5% + 5 digits)
		100 ~ 400 Hz	± (2.0% + 5 digits)

600.0 A	0.1 A	50 ~ 100 Hz	± (1.5% + 5 digits)
		100 ~ 400 Hz	± (2.0% + 5 digits)

Induced error from adjacent current-carrying conductors: < 0.1A/A

Safety Category Rating: CAT III 1000 V & CAT IV 600 V AC

12.11 Resistance Specifications

Range	Resolution	Accuracy
600.0 Ω	0.1 Ω	± (1.0% + 3 digits)
6.000 kΩ	0.001 kΩ	

Typical Constant Test Current: 0.1 uA

Open Circuit Voltage: 1.6 VDC

12.12 Continuity Specifications

Built-in beeper activates when measured resistance is < 30Ω and is silent when measured resistance is > 480Ω. Between 30 and 480Ω the beeper can be on or off.

Beeper response time: < 15 ms

12.13 Diode Specifications

Range	Accuracy
3.000 V	± (0.9 + 2 digits)

Test Current: 0.3 mA typical

Open Circuit Voltage: < 3.0 VDC typical

12.14 External (Flex) Clamp Adaptor — AC Current Specifications

Range	Frequency	Accuracy
30.00 A (100mV/A)	50 ~ 60 Hz (sine wave)	± (0.7% + 3 digits)*
300.0 A (10mV/A)		
3000A (1mV/A)		

30.00 A (100mV/A)	45~ 440 Hz (sine wave)	± (2.0% + 3 digits)*
300.0 A (10mV/A)		
3000A (1mV/A)		

*Does not include error introduced by the external clamp adaptor.

12.15 Temperature Specifications

Range	Accuracy ¹
-40.0 ~ 752°F	± (1.0% + 2°F)
-40.0 ~ 400°C	± (1.0% + 1°C)

1. Assumes meter interior and ambient temperature have reached stable isothermal stage for correct junction voltage compensation. Does not include error introduced by thermocouple probe.

*Assumes meter interior and ambient temperature have reached stable isothermal stage for correct junction voltage compensation. Does not include error introduced by thermocouple probe.

Supplied thermocouple is rated for -4 ~ 482°F (-20 ~ 250°C) only, and therefore not rated for the entire specified temperature range of the meter.

12.16 Input Specifications

Function	Overload Protection
Voltage, Current	1100V DC/AC RMS
Resistance, Temperature, Diode, Ext. Clamp adaptor, LoZ	1000V DC/AC RMS

12.17 Safety Specifications

General Safety	CE/EN/UL/RCM 61010
Safety Category ratings	CAT III 1000 V & CAT IV 600 V AC & DC
IP40 rated	Protected from tools and small wires greater than 1 millimeter
Environmental Safety	REACH Regulation EC 1907/2006 RoHS2 Directive 2011/65/EC WEEE Directive 2012/19/EC

Drop-proof	Designed to 3.3 ft. (1 m)
EMC	EN 61000-6-3 EN 61000-6-2 FCC 47 CFR Part 15 Class B

13 Three-Year Warranty

Please register your product within 60 days of purchase. Register your product at <https://support.flir.com/prodreg> or use the QR Code. Read the warranty text at the links provided.



Figure 13.1 Product Registration QR Code

14 Customer Support

Repair, Calibration, and Technical Support: <https://support.flir.com>.

14.1 Corporate Headquarters

FLIR Systems, Inc.

27700 SW Parkway Avenue

Wilsonville, OR 97070, USA



Website

<http://www.flir.com>

Customer support

<http://support.flir.com>

Copyright

© 2021, FLIR Systems, Inc. All rights reserved worldwide.

Disclaimer

Specifications subject to change without further notice. Models and accessories subject to regional market considerations. License procedures may apply. Products described herein may be subject to US Export Regulations. Please refer to exportquestions@flir.com with any questions.

Publ. No.: NAS100017
Release: AB
Commit: 75720
Head: 76078
Language: en-US
Modified: 2021-04-15
Formatted: 2021-04-26